

Pump construction, operating limits and performances

Close-coupled drivers are conventional drivers mounted directly to pumps frame. No base, coupling or guards are required for this mounting style.

- Connections: Threaded BSP (GAS) & NPT, Flange rating per DIN Norms Class PN25, ANSI B16.5 Class 150# and 300#
- Max viscosity: 10000cSt
- Max system pressure: 25bar (standard), 150bar (HP Version) Higher pressure version available on request.
- Flow up: to 3000 l/h
- Discharge pressure up to 12 bar
- Temperature range up to +200 °C (+392 °F)
- Electric motors: from 0,25kw up to 2,2Kw
- Available ATEX II - / 2G cbk II C T2 - T5

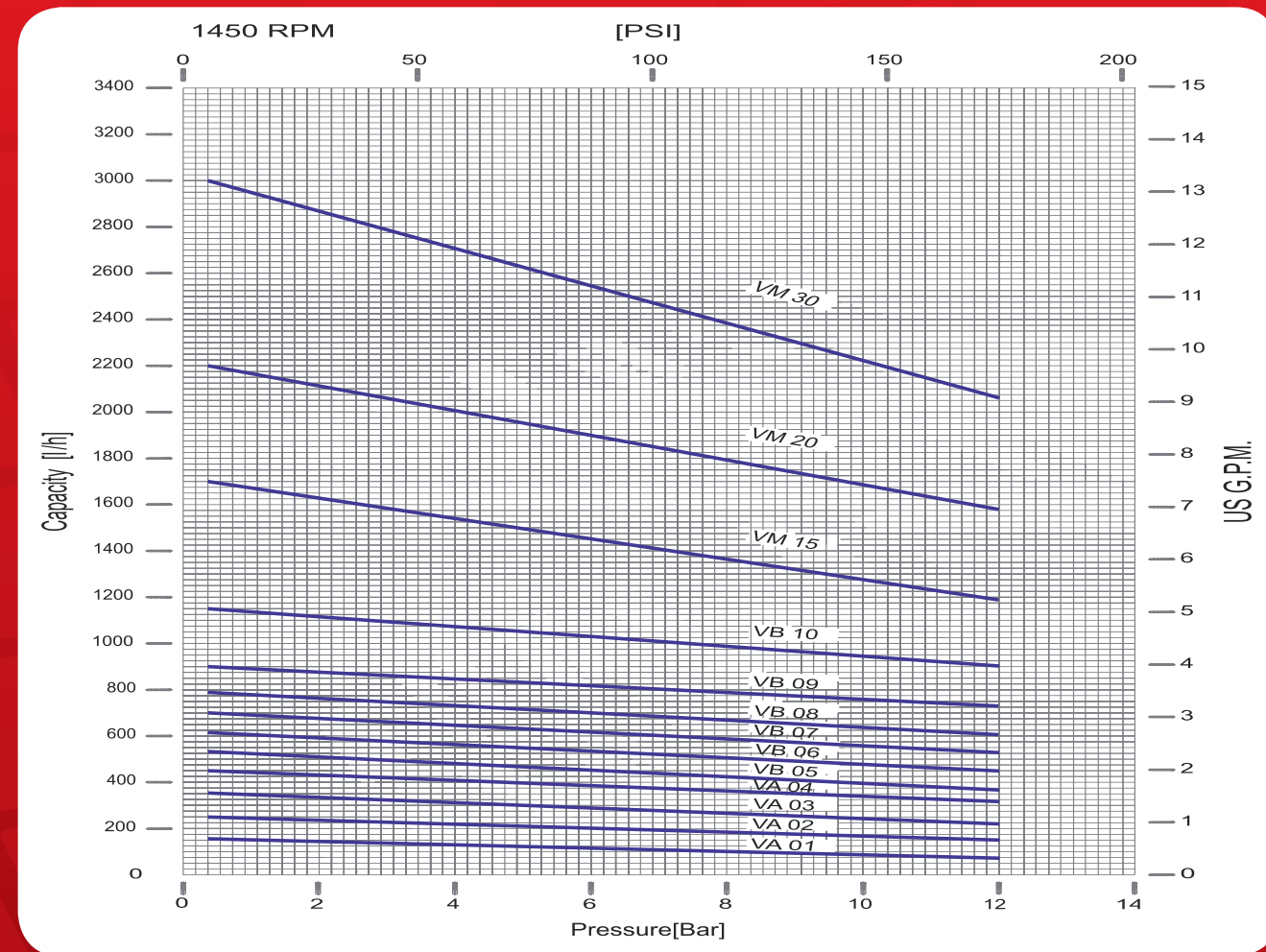

Manufactured by:



A unit of
Mischiatti
GROUP

M PUMPS s.r.l. - Via dell'Artigianato, 120
45015 Corbola (Ro) - Italy - www.mpumps.it
Tel. +39 0426 346304 - Fax +39 0426 349126

For more information please contact:



SEALLESS SLIDING VANE PUMP WITH PERMANENT MAGNET DRIVE SYSTEM, NO MECHANICAL SEAL

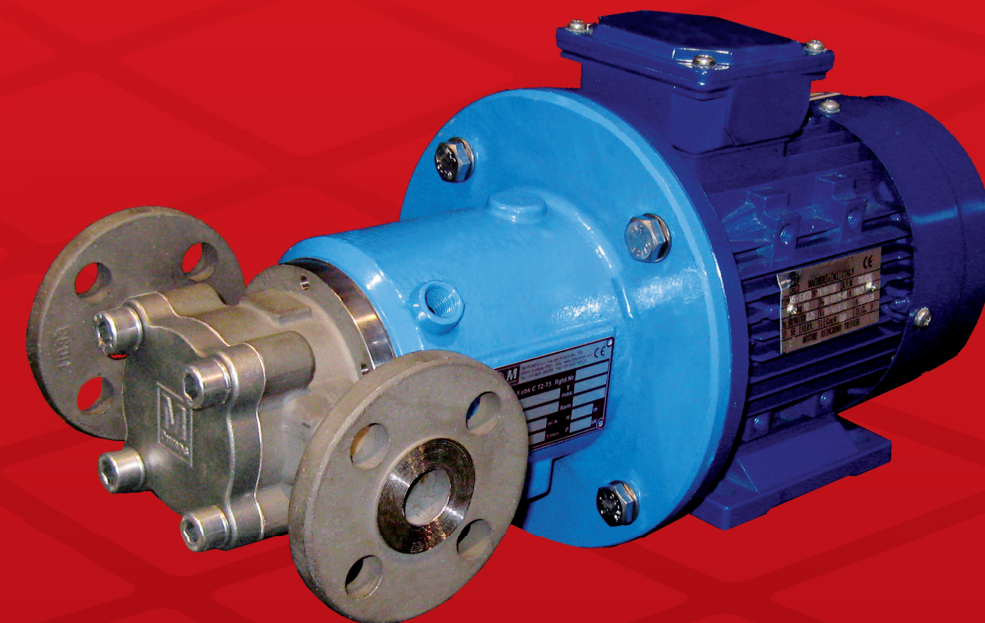

V IN LINE Series

The separation of liquid chamber/atmosphere by means of an isolation shell is the best solution to pump aggressive, explosive and toxic liquids, hydrocarbons, heat transfer liquids and liquids difficult to seal.

Suitable for a variety of applications, including reverse osmosis systems, cooling circulation and sampling application in refinery.

A wide range of pumps covers the different performances.

LINE

PUMP DETAILS

Epoxy primer and polyacrylic enamel water-based painting for the best quality resistance linked to the environmental respect.

The sealing system with O-Rings prevents product from leaking in the atmosphere – different materials available:

- Viton® (standard)
- EPDM
- FEP

CF8M Pump Casing & Cover High quality casting components.

- Other materials:
- Hastelloy® C276,
 - Incoloy® 825,
 - Duplex,
 - Others available on request.

QUICK CHANGE CARTRIDGE KIT to guarantee an easy and fast maintenance.

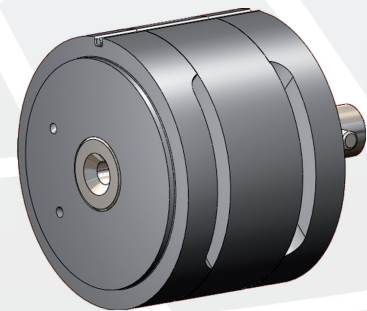

STANDARD VERSION: CARTRIDGE PHENOLIC GRAPHITE, ROTOR SS316.

"1 SiC" VERSION (For low viscosity or hot chemical resistance): CARTRIDGE METALLIZED CARBON, ROTOR SS316 W/SIC BEARINGS.

"2 SiC" VERSION (extreme differential pressure): CARTRIDGE METALLIZED CARBON or PHENOLIC GRAPHITE, ROTOR SS316 W/SIC BEARINGS VS SiC STATIONARY BEARINGS.

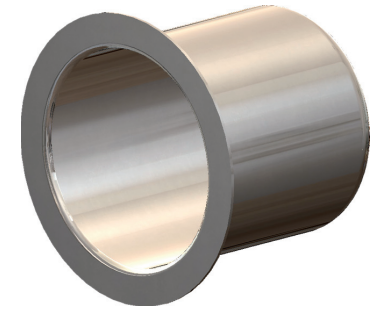
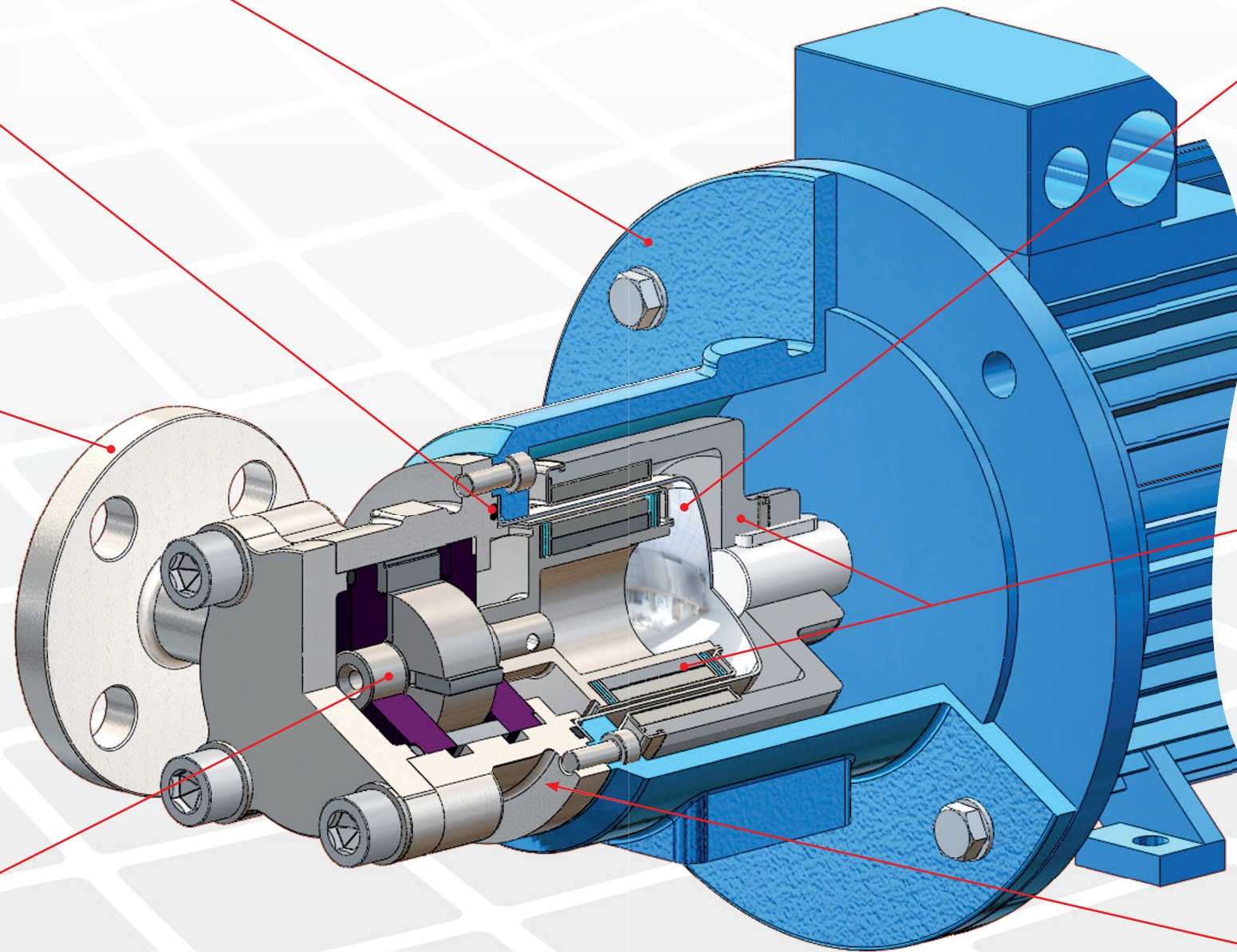

The rear shell is made of one single piece, no welding, ellipsoidal profile that has been studied to withstand higher pressures than the traditional one.

Available two versions, AISI 316 the standard construction, and Hastelloy® C276 for high pressure version-providing a safe and efficient solution—system pressure max 150bar. Titanium Alloy is an upgrade when higher pressure ratings and increased efficiency are required.

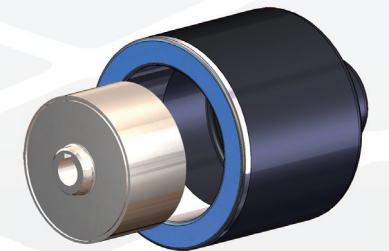

High power synchronous magnetic coupling designed by our Technical Office and with rare earth magnetic elements mechanically locked.

The high performance magnets can operate at liquid temperature of up to 392 °F (200 °C).

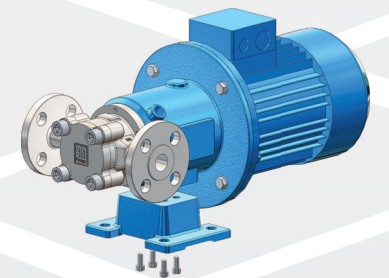

Many different connections are available:
Threaded BSP(GAS) or NPT.

DIN Flanges PN25, ANSI Class 150 and 300lbs.

Assembling foot permit to have the two versions available for motor B3B5 or B5.